

PLAN

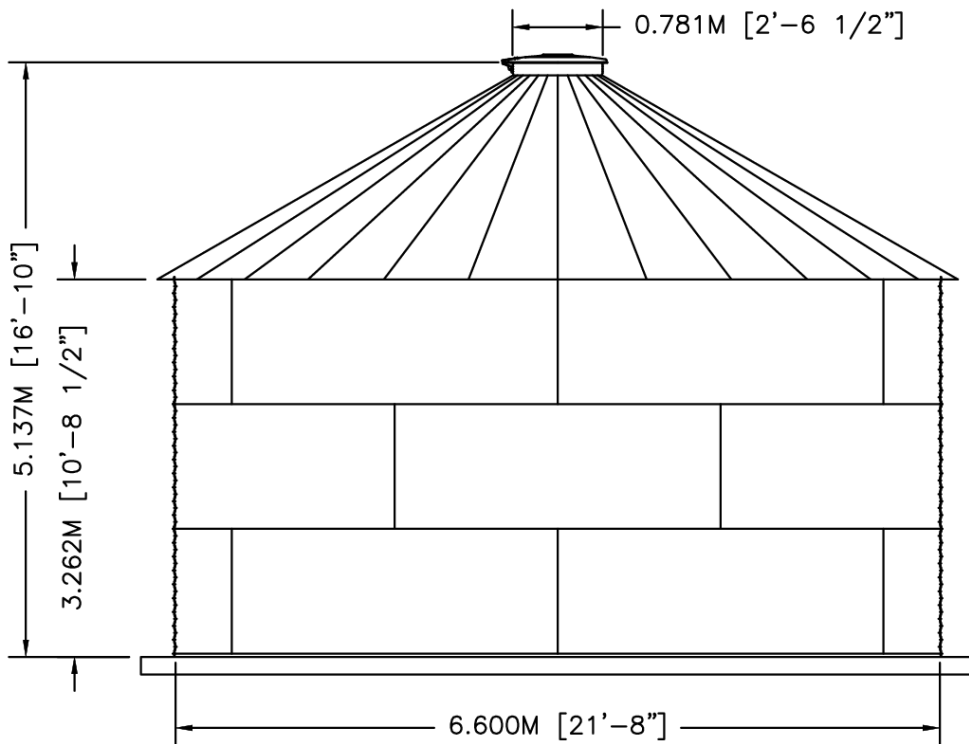

ELEVATION



	BY	DATE	TITLE	
DWN	XXX	XX/XX/XX	WTU07-03 30"PR 30DEG V-RIB	
CKD			NOMINAL CAPACITY - 107.335 M3 [28,355 GAL]	
ENG			DWG. NO. SCT2103-VR WTU07-03	REV. NO.
SIZE: A		SCALE: 3/16"=1'-0"		SHEET 1 OF 1